

NAVIGATOR RT-7000G2

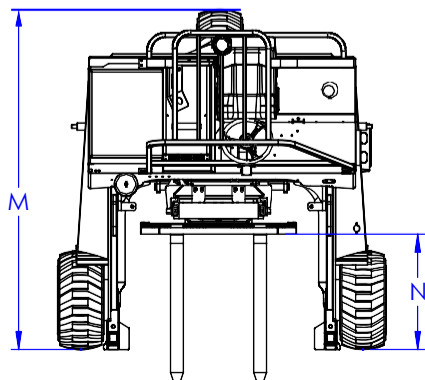
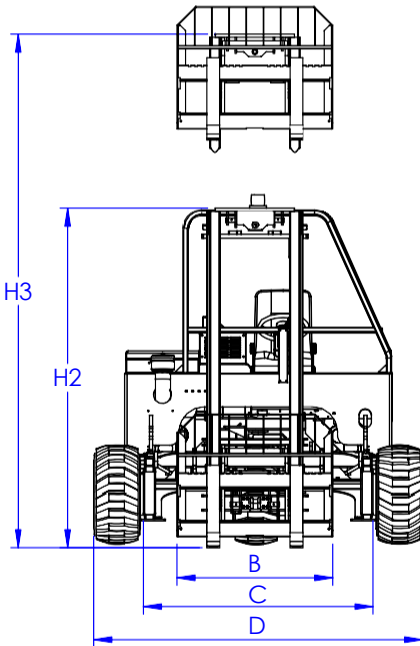
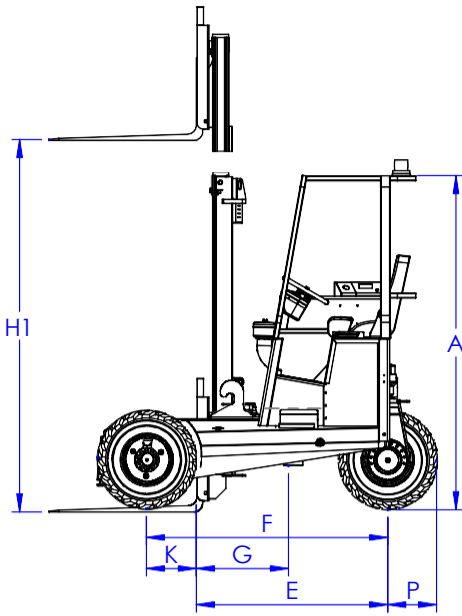

	MODEL	RT-7000G2
1	CAPACITY @ 24" LOAD CENTER	7,000 LBS
2	DIESEL ENGINE	59 HP KUBOTA
3	ENGINE EMISSION COMPLIANCE	EPA TIER4 FINAL
4	MAXIMUM RPM	2700 RPM
5	ELCECTRICAL SYSTEM	12 VOLT
6	DRIVE WHEELS	3
7	STEERING	HYDRAULIC
8	TIRE TYPE	31X13-16.5 (SS) 31X15.5-15 8-PLY (TG)
9	TIRE OUTSIDE DIAMETER (FRONT/REAR)	31.5"/31"
10	TIRE WIDTH (FRONT/REAR)	13"X15.5"
11	MAXIMUM SPEED	8 MPH
12	MAXIMUM GRADABILITY (4-WAY MODE)	30% (15%)
13	TURNING RADIUS	99"/105"
14	UNLADEN WEIGHT	7,120LBS/ 8,010LBS
15	WORKING PRESSURE (ATTACHMENTS)	3100 PSI
16	TILT OF MAST (FORWARD/BACKWARD)	10°/10°
17	SIDESHIFT DISTANCE	5"
18	FORK SECTION	2"x 5"x 48"
19	MAST CARRIAGE TRAVEL	29"
A	HEIGHT TO TOP OF CANOPY/ TO TOP OF STROBE	103.5"/107.5"
B	FORK CARRIAGE WIDTH (CLASS)	48"
C	FRAME OPENING	65.25"
D	OVERALL FRAME WIDTH	101.5"
E	OVERHANG	69"/75"
F	WHEELBASE	69"/75"
G	CENTER OF GRAVITY (FROM FORK FACE)	19"/24"
H1	LIFT HEIGHT	144"
H2	MAST HEIGHT - COLLAPSED	105"
H3	MAST HEIGHT - RAISED	183"
J	GROUND CLEARANCE	9.5"
K	FACE OF FORK TO CENTER OF FRONT TIRE	14"
L	ANSI STANDARD	B56.14
M	OVERALL LENGTH	99"/105"
N	FRONT FACE OF TIRE TO FACE OF FORK	31"
P	TIRE EXTENSION	15"

The above specifications are not binding upon the manufacturer and may be changed without prior notice. Weights may vary, depending on tire and/or fork options.

For more information, contact your local Navigator dealer.

Navigator Truck Mounted Forklifts
 7399 Beatline Road
 Long Beach, MS 39560 USA
 tel 1.228.864.6293
www.NavigatorForklift.com

